



Leading the way in
**Sustainable
Home Heating**

Envirogreen™ & Envirolite™ Boiler Range

Cutting edge Low
No_x Liquid Fuel
Burner Technology



Most
Efficient Boiler
in Europe

Beats
European No_x
Levels with
results as low
as 60mg per
kW/h



COMPREHENSIVE WARRANTIES ON ALL PARTS



Environment



Innovation



Technology

Free Home Heating Consultation – Call or Email Today

☎ UK: +44 (0)1752 691177 | NI: +44 (0)28 3088 8330 | IRL: +353 (0)26 45253

✉ UK: sales@firebird.uk.com | NI: salesni@firebird.ie | IRL: sales@firebird.ie

www.firebird.uk.com | www.firebird.ie



Contents

Introduction	3
--------------	---

Boilers	
Envirogreen™ Heatpac	8
Enviolite™ Heatpac	8
Envirogreen™ Slimline Heatpac	9
Envirogreen™ Popular	10
Enviolite™ Boilerhouse	10
Envirogreen™ Kitchen	11
Enviolite™ Utility	11
Envirogreen™ Combi HE	12
Envirogreen™ Slimline Combi HE	12
Envirogreen™ Combipac HE	13
Envirogreen™ System	14
Envirogreen™ Systempac	15
Envirogreen™ Slimline Systempac	16

Technical Specification	17
Condensing Flue Kits & Accessories	18



Taking Boiler Technology to the Next Level

Firebird Products Ltd are market-leading manufacturers of heating products with a proven track record built on the global supply of heating systems. Established in Ireland in 1980, the Firebird name has become synonymous with performance, quality and innovative design.

At the forefront of technology, Firebird are committed to providing cost-effective, energy-efficient heating solutions that not only meet, but easily exceed today's stringent legislative requirements. Historically an oil-fired boiler manufacturer; the addition of renewable heating options, which include air source heat pumps, biomass boilers and solar thermal systems enable Firebird to offer a total heating solutions package.



Why Choose a Firebird Boiler?

Research & Development

Firebird are committed to an ongoing programme of Research & Development and continue to lead the industry by providing the most innovative, technologically advanced and energy-efficient heating options available in today's market.

Innovative European Design

The positioning of the secondary heat exchanger in an oil-fired boiler is an important consideration to prevent against any corrosion of the boiler shell. In line with standard European practice, Firebird have designed a complete unit which houses the secondary heat exchanger beneath the primary heat exchanger. By locating this unit at the bottom of the appliance (rather than in the centre), the potential for corrosion of the boiler shell is eliminated.

Durable Construction

All Firebird oil-fired boilers are constructed from premium grade steel (minimum 4mm gauge). Internal models feature a heavy-duty casing, with a polyester-coated finish to provide optimum protection from normal wear and tear.

Extensive Product Range

With over 80 models available in outputs from 12kW to 100kW, Firebird offers the most comprehensive range of oil-fired boilers available for internal, external and boilerhouse applications.

Dedicated Service Engineers

All Firebird boilers are supported by both an in-house team and a national network of service engineers. This dedicated support service is available before, during or after the purchase of any Firebird boiler.

Firebird Training

Firebird offer a comprehensive programme of training courses for installers and service engineers which cover installation, commissioning, service and repair. These include training on fully operational boilers and are available at Firebird's training centre. Firebird's training van also travels to different locations across the country. For more information, please contact us at sales@firebird.uk.com.

Seasonal Efficiency Ratings

SEDBUK, which stands for Seasonal Efficiency of Domestic Boilers, is a system used to classify and compare boilers on how efficient they are at converting fuel into heat. The patented condensing heat exchanger, which forms an integral part of a Firebird boiler shell, enables more heat to be captured and reused, resulting in a higher seasonal efficiency figure.

Spare Parts

A comprehensive range of spare parts are available through a national network of approved stockists. For further information please contact sales@firebird.uk.com.

Delivery

Firebird holds unrivalled stock levels at their premises to ensure that even the most exacting delivery requirements can be met. Many products are available for next day delivery.



Go Green... Without Costing the Earth



Following a three year research and development programme, we are proud to launch the new **Envirogreen™** and **Enviolite™** low NO_x range of boilers. Designed specifically to meet the stringent environmental requirements of the second phase of the Ecodesign directive, the new range delivers advanced boiler technology without any associated price premium.

What are NO_x Emissions?

Nitrogen Oxide emissions – or NO_x emissions as they are more commonly known, is the general term that relates to the release of Nitrogen Dioxide (NO₂) and the chemically related colourless gas Nitrogen Monoxide (NO). These gases are released into the atmosphere when fossil fuels are burned at high temperatures. When in high concentrations, these potentially harmful by products of the combustion process are known to contribute to global pollution.

The Ecodesign Directive

The Ecodesign Directive is a European initiative which governs the design and performance of energy using products, to reduce the amount of energy consumed and the subsequent impact on the environment. New requirements on flue gas emissions state that harmful nitrogen oxide emissions from domestic liquid fuel boilers must not exceed 120mg/kWh.

The **Envirogreen™** and **Enviolite™** Story

At Firebird we are no strangers to innovation, having developed the most efficient domestic liquid fuel fired boiler in Europe. Whilst meeting all the environmental criteria, the downside to this particular type of technology is the cost, resulting in a premium priced boiler.

We therefore set ourselves a challenge to design a boiler that exceeded the NO_x reduction requirements, offered the same outstanding level of performance, but most importantly remained an affordable option for our customers.

Following an extensive research and development programme, in conjunction with European burner experts elco, the **Envirogreen™** and **Enviolite™** range was born. Featuring cutting-edge burner technology this new range ticks every box.

- ✓ **Meets NO_x reduction requirements.**
- ✓ **Performance data listed on the Product Characteristics Database (PCDB).**
- ✓ **Easy to install and service.**
- ✓ **Cost-effective.**

Why Choose Envirogreen™ & Envirolite™ ?



Installer

- ✓ **Trouble-Free Plug & Play Burner**
Key components easily identified by dedicated connectors.
- ✓ **Fast & Easy to Install**
Main component parts undone with a single Allen key.
- ✓ **Easy to Service & Maintain**
Components clearly positioned and accessible.
- ✓ **Makes Financial Sense**
No associated price premium.
- ✓ **Simple Diagnostic System**
Optimised wiring system.
- ✓ **Standard Firebird Digital Control Box**
Reliable and simple to use with handy reset button.
- ✓ **Excellent Cold Start Performance.**
- ✓ **Powerful Ignition System**
With separate powerful transformer.
- ✓ **Low Smoke, Clean Burn Reduces Carbon Build-up**
Both on burner combustion head and boiler.
- ✓ **Excellent Combustion Robustness**
CO₂ level factory-set at an optimum 12.5% ensures highest levels of efficiency.
- ✓ **100% 'Burner Test Fired' to 12.5% CO₂ Levels.**
- ✓ **Outstanding Ventilation Performance**
Ensures complete combustion.
- ✓ **Post Purge as Standard.**
- ✓ **Latest Danfos Pump Technology**
Up to 100m suction capacity.
- ✓ **Single-Forge Combustion Head.**
- ✓ **Latest Condensate Trap Technology**
With 316L stainless steel.
- ✓ **Adjustable Feet on all Boilerhouse Models.**
- ✓ **Product Characteristics Database (PCDB) listed.**
- ✓ **Listed on the Heating Appliance Register of Performance (HARP).**



Installation is as easy as 1, 2, 3

2x

Burner Settings



3x

Satisfied Customers



Environment

✓ **Low NO_x Compliant**

Exceeds current requirements of the second phase of the Ecodesign Directive.

✓ **Superior Flue Gas Recirculation**

Significantly reduces NO_x emissions.

✓ **Extremely Low Carbon Monoxide (CO) Emissions.**

✓ **Low Electrical Consumption.**



Homeowner

✓ **Makes Financial Sense**

Increased operating efficiency saves fuel and reduces bills.

✓ **Ultra-Reliable**

No error prone complex parts.

✓ **Helping the environment.**



Envirogreen™ Heatpac & Envirolite™ Heatpac



Envirogreen™ & Envirolite™ Model	Product Code	Weight kg	ErP Rating	Dimensions (mm)		
			Heating	H	W	D
Envirogreen™ Heatpac 12-18kW	EGE018HPK	134	A	945	620	625
Envirogreen™ Heatpac 12-20kW	EGE020HPK	154	A	945	720	625
Envirogreen™ Heatpac 20-26kW	EGE026HPK	154	A	945	720	625
Envirogreen™ Heatpac 26-35kW	EGE035HPK	158	A	945	720	625
Envirogreen™ Heatpac 36-44kW	EGE044HPK	244	A	1074	839	855
Envirogreen™ Heatpac 58kW	EGE058HPK	250	A	1074	839	855
Envirogreen™ Heatpac 73kW	EGE073HPK	280	A	1200	903	855
Envirolite™ Heatpac 12-20kW	EGE020SGR	154	A	945	720	625
Envirolite™ Heatpac 20-26kW	EGE026SGR	154	A	945	720	625
Envirolite™ Heatpac 26-35kW	EGE035SGR	158	A	945	720	625

Features

- High quality weather-proof PVC-coated casing (outputs up to 58kW).
- Fully insulated to prevent heat loss.
- Patented heat exchanger design.
- Removable side panels for easy access.
- 4-tapping points for ease of installation.
- Fitted with frost protection stat
- Whisper quiet operation.
- Stainless steel terminal guard.
- High performance low NOx Elco burner.
- Seven models available in outputs from 12kW to 73kW.

Envirogreen™ Slimline Heatpac



Envirogreen™ Model	Product Code	Heating Output Max.	Weight kg	ErP Rating	Dimensions (mm)		
				Heating	H	W	D
Envirogreen™ Slimline Heatpac 12-20kW	EGE020SLM	20kW	147	A	920	465	760
Envirogreen™ Slimline Heatpac 20-26kW	EGE026SLM	26kW	150	A	920	465	760
Envirogreen™ Slimline Heatpac 26-35kW	EGE035SLM	35kW	153	A	920	465	760

Features

- High quality weather-proof PVC-coated casing.
- Only 465mm wide.
- Fully insulated to prevent heat loss.
- Patented heat exchanger design.
- Removable back panel for easy access.
- 3-tapping points for ease of installation.
- Fitted with frost protection stat.
- Whisper quiet operation.
- Stainless steel terminal guard.
- High performance low NOx Elco burner.
- Three models available in outputs from 12kW to 35kW.

Envirogreen™ Popular & Envirolite™ Boilerhouse



Envirogreen™
Popular

Envirolite™
Boilerhouse



Envirogreen™ & Envirolite™ Model	Product Code	Weight kg (including burner)	ErP Rating	Dimensions (mm)		
			Heating	H	W	D
Envirogreen™ Popular 12-18kW	EGE018POP	99	A	684	344	381
Envirogreen™ Popular 12-20kW	EGE020POP	107	A	684	441	381
Envirogreen™ Popular 20-26kW	EGE026POP	112	A	684	441	381
Envirogreen™ Popular 26-35kW	EGE035POP	115	A	684	441	381
Envirogreen™ Popular 36-44kW	EGE044POP	182	A	815	470	531
Envirogreen™ Popular 58kW	EGE058POP	190	A	815	470	533
Envirogreen™ Popular 73kW	EGE073POP	210	A	873	530	527
Envirogreen™ Popular 80-100kW	EGE100POP	300	A	1052	625	746
Envirolite™ Boilerhouse 12-20kW	EGE020SBH	107	A	684	441	381
Envirolite™ Boilerhouse 20-26kW	EGE026SBH	112	A	684	441	381
Envirolite™ Boilerhouse 26-35kW	EGE035SBH	115	A	684	441	381

Features

- Patented heat exchanger design.
- Built from premium quality steels.
- Compact design.
- 4-tapping points for ease of installation.
- Sturdy well insulated casing minimises heat loss.
- High performance low NOx Elco burner.
- Eight models available in outputs from 12kW to 100kW.

Envirogreen™ Kitchen & Enviolite™ Utility



Envirogreen™ & Envioilite™ Model	Product Code	Weight kg	ErP Rating	Dimensions (mm)		
			Heating	H	W	D
Envirogreen™ Kitchen 12-18kW	EGE018KIT	115	A	847	345	610
Envirogreen™ Kitchen 12-20kW	EGE020KIT	125	A	847	442	610
Envirogreen™ Kitchen 20-26kW	EGE026KIT	128	A	847	442	610
Envirogreen™ Kitchen 26-35kW	EGE035KIT	131	A	847	442	610
Envirogreen™ Kitchen 36-44kW	EGE044KIT	210	A	1048	464	852
Envirogreen™ Kitchen 58kW	EGE058KIT	216	A	1048	464	852
Envirogreen™ Kitchen 73kW	EGE073KIT	242	A	1196	524	851
Envirogreen™ Commercial Utility 80-100kW	EGE100KIT	390	A	1249	623	1071
Envioilite™ Utility 12-20kW	EGE020UTL	125	A	845	442	610
Envioilite™ Utility 20-26kW	EGE026UTL	128	A	845	442	610
Envioilite™ Utility 26-35kW	EGE035UTL	131	A	845	442	610

Features

- Compact design - fits under standard kitchen worktop (outputs up to 35kW).
- Hard wearing casings with premium quality finish.
- Patented heat exchanger design.
- 4-tapping points for ease of installation.
- Front service access.
- Multi directional flue options.
- PCB controller with anti cycling function (outputs up to 35kW).
- Fully insulated and acoustically designed for ultra quiet operation.
- High performance low NOx Elco burner.
- Optional condensate pump.
- Eight models available in outputs from 12kW to 100kW.

Envirogreen™ Combi HE & Envirogreen™ Slimline Combi

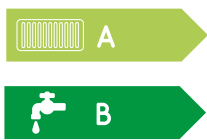

Envirogreen™ Model	Product Code	Weight kg	ErP Rating		Dimensions (mm)		
			Heating	Hot Water	H	W	D
Envirogreen™ Combi HE 12-20kW	ECE020DLX	167	A	B	845	595	614
Envirogreen™ Combi HE 20-26kW	ECE026DLX	170	A	B	845	595	614
Envirogreen™ Combi HE 26-35kW	ECE035DLX	173	A	B	845	595	614
Envirogreen™ Slimline Combi 12-20kW	ECE020SLM	165	A	B	855	520	600
Envirogreen™ Slimline Combi 20-26kW	ECE026SLM	168	A	B	855	520	600
Envirogreen™ Slimline Combi 26-35kW	ECE035SLM	172	A	B	855	520	600

Features

- Excellent hot water performance.
- Rapid re-heat after hot water draw-off.
- PCB controller with highly accurate thermistors.
- Fully insulated and acoustically designed for ultra quiet operation.
- Hard wearing casings with high quality finish.
- Compact design - fits under standard kitchen worktop.
- No flow switch - water flow is electronically detected.
- Multi directional flue options.
- High performance low NOx Elco burner.
- Patented heat exchanger design.
- Easy to install and service.

Combi HE Features

- Single high efficiency Grundfos circulating pump.
- Low pressure switch protects boiler in the unlikely event of system water loss.
- Robust “positive shut-off” filling loop and check valve.
- Three models available in outputs from 12kW to 35kW.

Slimline Combi Features

- Twin circulating pump - no diverter valve required.
- Optional condensate pump and timer controllers.
- Three models available in outputs form 12kW to 35kW.

Envirogreen™ Combipac HE

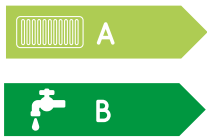

Envirogreen™ Model	Product Code	Weight kg	ErP Rating		Dimensions (mm)		
			Heating	Hot Water	H	W	D
Envirogreen™ Combipac HE 12-20kW	ECE020CPK	200	A	B	945	720	625
Envirogreen™ Combipac HE 20-26kW	ECE026CPK	200	A	B	945	720	625
Envirogreen™ Combipac HE 26-35kW	ECE035CPK	203	A	B	945	720	625

Features

- Excellent hot water performance.
- High quality weatherproof PVC coated casings.
- Removable sides for ease of access.
- Factory fitted frost protection stat.
- Single high efficiency Grundfos circulating pump.
- Rapid re-heat after hot water draw-off.
- PCB controller with highly accurate thermistors.
- Fully insulated and acoustically designed for ultra quiet operation.
- No flow switch - water flow is electronically detected.
- Low pressure switch protects boiler in the unlikely event of system water loss.
- Robust “positive shut-off” filling loop and check valve.
- Multi-directional flue options.
- High performance low NOx Elco burner.
- Three models available in outputs from 12kW to 35kW.

Envirogreen™ System



Envirogreen™ Model	Product Code	Weight kg	ErP Rating	Dimensions (mm)		
			Heating	H	W	D
Envirogreen™ System 12-20kW	ESE020DLX	143	A	847	442	610
Envirogreen™ System 20-26kW	ESE026DLX	146	A	847	442	610
Envirogreen™ System 26-35kW	ESE035DLX	149	A	847	442	610
Envirogreen™ System 36-44kW	ESE044DLX	235	A	1048	660	852

Features

- Compact design - fits under standard kitchen worktop (outputs up to 35kW).
- Low pressure switch protects boiler in the unlikely event of system water loss.
- Hard wearing casings with premium quality finish.
- Patented heat exchanger design.
- Front service access.
- PCB controller with anti cycling function (outputs up to 35kW).
- Fully insulated and acoustically designed for ultra quiet operation.
- Multi directional flue options.
- High performance low NOx Elco burner.
- Optional condensate pump.
- Four models available in outputs from 12kW to 44kW.

Envirogreen™ Systempac



Envirogreen™ Model	Product Code	Weight kg	ErP Rating	Dimensions (mm)		
			Heating	H	W	D
Envirogreen™ Systempac 12-20kW	ESE020NKT	163	A	945	720	625
Envirogreen™ Systempac 20-26kW	ESE026NKT	163	A	945	720	625
Envirogreen™ Systempac 26-35kW	ESE035NKT	166	A	945	720	625
Envirogreen™ Systempac 36-44kW	ESE044NKT	270	A	1074	839	855

Features

- High quality weather-proof PVC-coated casing.
- Low pressure switch protects boiler in the unlikely event of system water loss.
- Factory-fitted expansion vessel and circulating pump saves space and installation time.
- Fully insulated to prevent heat loss.
- Patented heat exchanger design.
- Fitted with frost protection stat.
- Ultra quiet operation.
- Stainless steel terminal guard.
- Flue can exit left or right.
- High performance low NOx Elco burner.
- Four models available in outputs from 12kW to 44kW.

Envirogreen™ Slimline Systempac



Envirogreen™ Model	Product Code	Weight kg	ErP Rating	Dimensions (mm)		
			Heating	H	W	D
Envirogreen™ Slimline Systempac 12-20kW	ESE020SLM	147	A	920	465	760
Envirogreen™ Slimline Systempac 20-26kW	ESE026SLM	150	A	920	465	760
Envirogreen™ Slimline Systempac 26-35kW	ESE035SLM	153	A	920	465	760

Features

- Three directional flue options.
- Pre-plumbed and pre-wired.
- Easy access to pre-wired circulating pump.
- Connection to pipework can be made from the base.
- High performance low NOx Elco burner.
- High quality weather-proof casing.
- Factory-fitted expansion vessel and circulating pump saves space and installation time.
- Fully insulated to prevent heat loss.
- Patented heat exchanger design.
- Fitted with frost protection stat.
- Ultra quiet operation.
- Stainless steel terminal guard.
- Removable sides for ease of access.
- Suitable for open vented and sealed systems.

Technical Specifications

Envirogreen™ & Envirolite™

		Combi HE / Slimline Combi / Combipac HE			System / Systempac / Slimline Systempac			Heatpac / Slimline Heatpac / Popular / Boilerhouse / Kitchen / Utility				
HEAT OUTPUT	kW	12-20 20-26	26-35	12-20 20-26	26-35	36-44	12-18	12-20 20-26	26-35	36-44 58	73	80-100
CONNECTIONS												
Heating Flow		22mm dia.	28mm dia.	22mm dia.	28mm dia.	1½" BSP	1" BSP	1" BSP	1" BSP	1½" BSP	1½" BSP	2" BSP
Heating Flow Slimline Systempac		-	-	1" CxC	-	-	-	-	-	-	-	-
Heating Return		22mm dia.	28mm dia.	1" BSP	1" BSP	1½" BSP	1" BSP	1" BSP	1" BSP	1½" BSP	1½" BSP	2" BSP
Heating Return Slimline Systempac		-	-	1" CxC	-	-	-	-	-	-	-	-
Mains Cold Feed (Copper)		15mm dia.	15mm dia.	15mm dia.	15mm dia.	15mm dia.	-	-	-	-	-	-
Hot Water Delivery (Copper)		15mm dia.	15mm dia.	-	-	-	-	-	-	-	-	-
Drain Off Valve		½" BSP	½" BSP	½" BSP	½" BSP	½" BSP	½" BSP	½" BSP	½" BSP	½" BSP	½" BSP	½" BSP
Safety Pressure Valve Outlet (Copper)		15mm dia.	15mm dia.	15mm dia.	15mm dia.	15mm dia.	-	-	-	-	-	-
Condensate Trap		22mm dia.	plastic	22mm dia.	plastic				22 mm dia.	plastic		
Boiler Boiler		24 litres	24 litres	24 litres	24 litres	45 litres	24 litres	24 litres	24 litres	43.5 litres	54 litres	75 litres
Primary Tank	Combi HE	20 litres	20 litres	-	-	-	-	-	-	-	-	-
	Slimline Combi	11 litres	11 litres	-	-	-	-	-	-	-	-	-
	Combipac HE	20 litres	20 litres	-	-	-	-	-	-	-	-	-
CIRCULATING PUMP												
Domestic Hot Water Plate Heat Exchanger		25 plate	31 plate	-	-	-	-	-	-	-	-	-
Integral Expansion Vessel Normal Capacity		12 litres	12 litres	12 litres	12 litres	18 litres	-	-	-	-	-	-
Expansion Vessel Pre-charge Pressure		1 bar	1 bar	1 bar	1 bar	1 bar	-	-	-	-	-	-
Low Pressure Water Switch?		✓	✓	✓	✓	✓	✗	✗	✗	✗	✗	✗
Filling Loop Included?		✓	✓	✓	✓	✓	✗	✗	✗	✗	✗	✗
D.H.W. GUIDE PERFORMANCE*												
		In litres/min (120 litre draw-off at 40°C Δt.)										
	Combi HE	16	20	-	-	-	-	-	-	-	-	-
	Slimline Combi	14	16	-	-	-	-	-	-	-	-	-
	Combipac HE	16	20	-	-	-	-	-	-	-	-	-
FLUE (INTERNAL BOILERS)												
Balanced Flue Assembly		125 (5") mm dia.	125 (5") mm dia.	125 (5") mm dia.	125 (5") mm dia.	150 (6") mm dia.	125 (5") mm dia.	125 (5") mm dia.	125 (5") mm dia.	150 (6") mm dia.	180 (7") mm dia.	200 (8") mm dia.
Flue Assembly		-	-	80 (3") mm dia.	-	-	-	-	-	-	-	-
Max. Low Level Flue Length		1.5m	1.5m	1.5m	1.5m	1.5m	1.5m	1.5m	1.5m	1.5m	1.5m	1.5m
Max. High Level Balanced Flue Length		6m	6m	6m	6m	6m	6m	6m	6m	6m	6m	6m
Max. Vertical Plume Length		-	-	5m	-	-	-	-	-	-	-	-
Integral flues on Heatpac models		-	-	-	-	-	-	-	-	-	-	-
HEATING SYSTEM (SEALED)												
		Fit in accordance with BS 7074 Part 1, BS 5449, OFTEC standards and all other relevant legislation.										
Max. Operating Pressure		2 bar		2 bar			-					
Max. System Pressure Cold		1.5 bar		1.5 bar			-					
Min. System Pressure Cold		0.5 bar		0.5 bar			-					
Preset Pressure Relief Valve		3 bar		3 bar			3 bar					
MAINS WATER SUPPLY PRESSURE												
		Min. 3 bar - Max. 5 bar (for user comfort, we recommend pressure at tap to be between 2 and 3 bar)										
		Limescale excess: When over 150/200 ppm, fit appropriate scale reducer/water softener.										
WATER SIDE RESISTANCE												
		Flow Rate to give a Nominal Output at 10K Differential					12-20kW	20-26kW	26-35kW	36-44kW		
		Flow Rate Measured (kg/h)					1642	2135	2874	3613		
		Waterside Resistance (mbar)					0.18	0.18	0.18	0.22		
		Flow Rate to give a Nominal Output at 20K Differential										
		Flow Rate Measured (kg/h)					870	1131	1523	2915		
		Waterside Resistance (mbar)					0.19	0.19	0.19	0.24		
PRESSURE JET OIL BOILERS												
		ELCO FB 2 K LN 12-58 and ELCO FB 3 K LN for 73kW and 100kW										
FUEL												
		Kerosene 28 Second Class C2										
ELECTRICAL SUPPLY												
		230V AC 50Hz 5A										
TEMPERATURE CONTROL												
		Frost thermostat fitted to all outdoor models										
Boiler Central Heating Control		60°C – 80°C		60°C – 80°C			60°C – 80°C					
Boiler Safety Limit		110°C		-			110°C					
Tank (DHW)- Fixed		78°C		-			-					
Early Alert - Fixed		87°C		-			-					
Over-run - Fixed		93°C		87°C			87°C (Envirolite Heatpac, Heatpac, Envirolite Utility and Kitchen only)					

Thermostats have an operating tolerance of ± 4°C

* where water demand exceeds this, a flow restrictor is recommended. This will ensure a water supply at an adequate temperature.

Condensing Flue Kits

Firebird Products Ltd offer a comprehensive range of plastic and stainless steel condensing flue kits to complement the extensive range of oil-fired boilers. A flue is a critical part of boiler installation and a necessary requirement to remove gases created during the combustion process. A correctly installed flue will also ensure the clean and efficient operation of the boiler, resulting in optimum boiler performance and a longer design life. An incorrect installation will result in the boiler warranty becoming invalid.



!
NB: Only Firebird approved flue kits and accessories may be used on Firebird boilers. Use of unapproved flue kits may invalidate the boiler warranty policy.

Plas-Fit Plastic Flue Kits & Accessories

Firebird was the first oil boiler manufacturer to introduce plastic flue kits to the UK market. The Plast-Fit range of plastic balanced flue kits provides flexibility, ease of installation and an aesthetically pleasing high-quality finish. Available in both Low Level and High Level options, the Plas-Fit flue kits are suitable for use with the **Envirogreen™** and **Enviolite™** ranges of boilers in outputs from 12kW to 35kW.

CPF005HHL



CPF005VHL



Product Code	Product Description
12-35kW	KITS (125mm dia)
CPF005KIT	PLAS-FIT Low Level Balanced Flue Kit (1 metre)
CPF005VHL	PLAS-FIT Vertical Balanced Flue Kit (3 metres)
CPF005HHL	PLAS-FIT High Level Flue Kit
12-35kW	ACCESSORIES (125mm dia)
CPF005EXA	PLAS-FIT Extension, 1000mm
CPF005EXB	PLAS-FIT Extension 500mm
CPF455ELB	PLAS-FIT 45 degree Elbow (pair)
CPF905ELB	PLAS-FIT 90 degree Elbow
CPF005WBK	Wall Bracket to suit PLAS-FIT
12-35kW	PLUME DISPERSAL (80mm dia)
PDK005CPF	PLAS-FIT Plume Management Kit
PDK045PBD	80mm Plas-Fit Plume 45 degree Elbow
PDK090PBD	80mm Plas-Fit Plume 90 degree Elbow
PDK005PXA	80mm Plas-Fit Plume 1000mm Extension
PDK005PWB	80mm Plas-Fit Plume Wall Bracket



Stainless Steel Flue Kits & Accessories

The Firebird range of stainless steel flue kits and accessories are suitable for use with the **Envirogreen™** and **Enviolite™** ranges of boilers. Stainless steel flue kits are available for the following applications:

- Low level flue (including plume dispersal)
- Conventional flue
- High level flue (vertical & horizontal)

Low Level Flue Kits

Low level flue kits have become popular in recent years due to their convenient size and ease of installation. When installing a condensing low level flue, consideration should be given to the discharge of the condense plume. In some circumstances a plume dispersal kit may be necessary.



Product Code	Product Description
20-35kW	KITS AND EXTENSIONS (125mm dia)
A CBF005KIT	Low Level Flue Kit 380-600mm Stainless Steel Guard inc.
A CBF005SKT	Low Level Flue Kit (short) 200-280mm Stainless Steel Guard inc.
B CBF005EXT	450mm Extension for Low Level Flue Kit
44-58kW	KITS AND EXTENSIONS (150mm dia)
A CBF006KIT	Low Level Flue Kit 380-600mm Stainless Steel Guard inc.
A CBF006SKT	Low Level Flue Kit (short) 200-280mm Stainless Steel Guard inc.
B CBF006EXT	450mm Extension for Low Level Flue Kit
73kW	KITS AND EXTENSIONS (185mm dia)
A CBF007KIT	Low Level Flue Kit 380-600mm Stainless Steel Guard inc.
A CBF007SKT	Low Level Flue Kit (short) 200-280mm Stainless Steel Guard inc.
B CBF007EXT	450mm Extension for Low Level Flue Kit

*A - Low Level Flue Kit

All Low Level Flue Kits contain:

- Telescopic Balanced Flue with Venturi Insert
- Terminal Guard
- Deflector Plate
- Silicone Lubricant
- Jubilee Clip for Air Snorkel
- Assembly Instructions

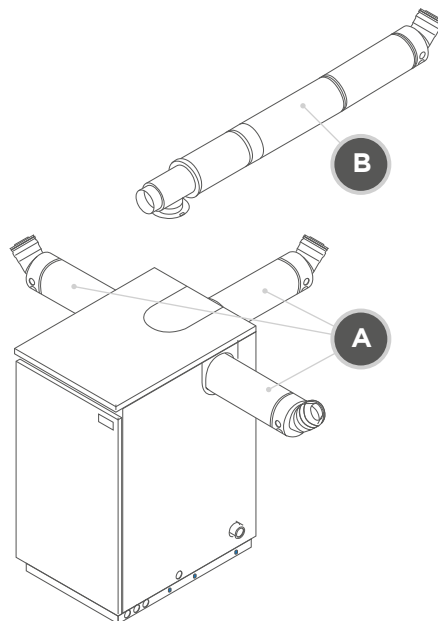

!
NB: Only Firebird approved flue kits and accessories may be used on Firebird boilers. Use of unapproved flue kits may invalidate the boiler warranty policy.

Stainless Steel Flue Kits & Accessories

Plume Dispersal Kits

A plume dispersal kit can be connected to the exhaust terminal of a low level flue in order to discharge flue gases (plume) up, over head height and neighbouring properties. Plume dispersal options can be used with a kit or retrofitted to an existing concentric flue.

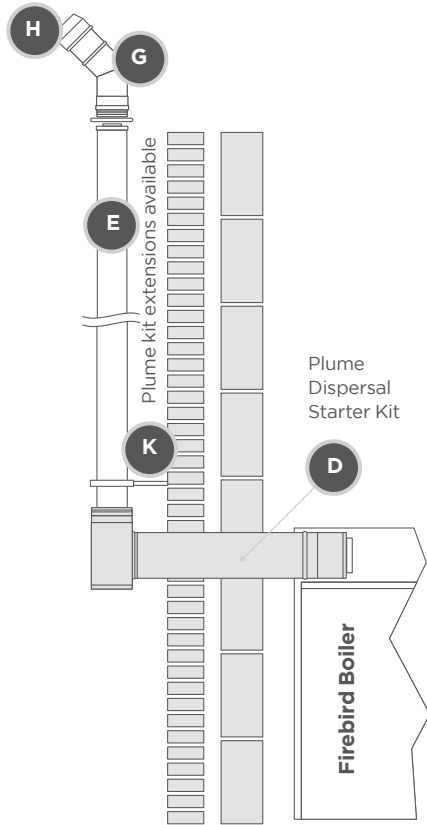

Product Code	Product Description
12-35kW KIT AND EXTENSIONS (80mm dia)	
D	PDK125KIT 5" Plume Dispersal Balanced Flue Starter Kit
E	PDK250KIT 250mm Length
E	PDK500KIT 500mm Length
E	PDK1000KT 1000mm Length
F	PDK420KIT 305-420 Adjustable Length
F	PDK920KIT 555-920 Adjustable Length
G	PDK045BND 45 degree Bend
H	PDK000HLE Terminal Insert
I	PDK090BND 90 degree Bend
J	PDK000CHC Cowl
K	PDK000WBK Wall Bracket
	PDK080POP Boiler Plume Flue Adaptor
44-58kW KIT AND EXTENSIONS (100mm dia)	
D	PDK150KIT Plume Dispersal Balanced Flue Starter Kit
E	PDK256KIT 250mm Length
E	PDK506KIT 500mm Length
E	PDK1006KT 1000mm Length
F	PDK426KIT 305-420 Adjustable Length
F	PDK926KIT 555-920 Adjustable Length
G	PDK456BND 45 degree Bend
H	PDK006HLE Terminal Insert
I	PDK906BND 90 degree Bend
J	PDK006CHC Cowl
K	PDK006WBK Wall Bracket
	PDK100POP Boiler Plume Flue Adaptor
73kW KIT AND EXTENSIONS (125mm dia)	
E	PDK257KIT 250mm Length
E	PDK507KIT 500mm Length
E	PDK1007KT 1000mm Length
F	PDK427KIT 305-420 Adjustable Length
F	PDK927KIT 555-920 Adjustable Length
G	PDK457BND 45 degree Bend
H	PDK007HLE High Level Elbow Terminal
I	PDK907BND 90 degree Bend
J	PDK007CHC Cowl
K	PDK007WBK Wall Bracket
	PDK125POP Boiler Plume Flue Adaptor
100kW KIT AND EXTENSIONS (150mm dia)	
E	PDK258KIT 250mm Length
E	PDK508KIT 500mm Length
E	PDK1008KT 1000mm Length
F	PDK428KIT 305-420 Adjustable Length
F	PDK928KIT 555-920 Adjustable Length
G	PDK458BND 45 degree Bend
H	PDK008HLE High Level Elbow Terminal
I	PDK908BND 90 degree Bend
J	PDK008CHC Cowl
K	PDK008WBK Wall Bracket
	PDK150POP Boiler Plume Flue Adaptor

Other components available

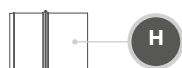
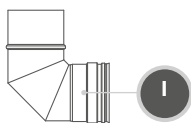
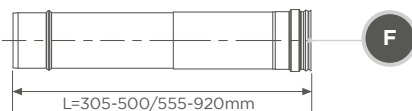

Stainless Steel Flue Kits & Accessories

Conventional Flue Kits

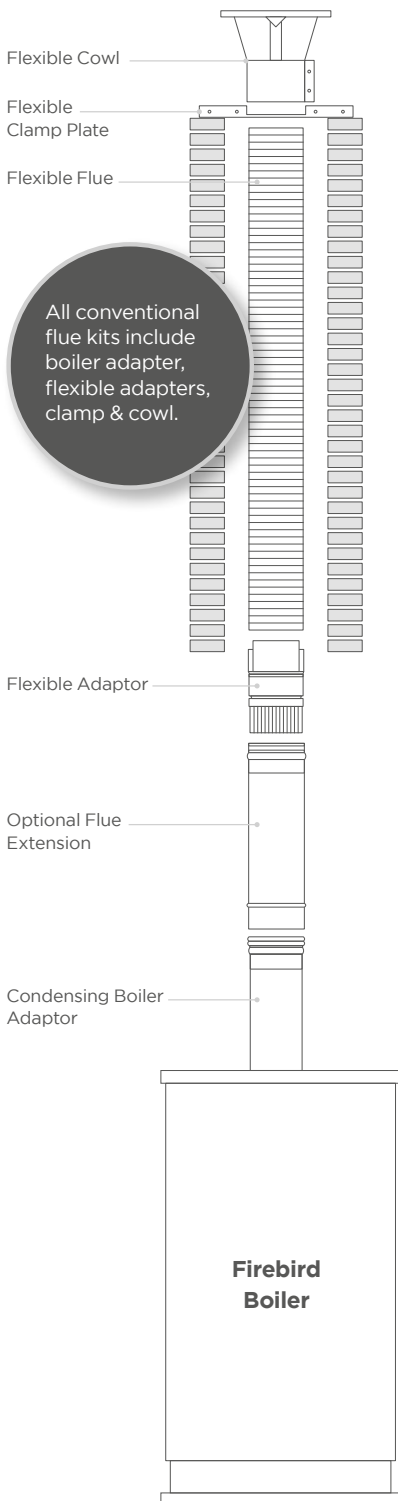

Product Code	Product Description
12-35kW	
KITS & EXTENSIONS (100mm dia) (Kit contents include boiler and flex adaptor, clamp and cowl)	
ECF003KIT	3m Kit
ECF006KIT	6m Kit
ECF008KIT	8m Kit
ECF010KIT	10m Kit
ECF012KIT	12m Kit
ECF014KIT	14m Kit
ECF016KIT	16m Kit
ECF100EXB	1000mm Length White
ECF100EXC	500mm Length White
ECF100EXD	250mm Length White
ECF250ADJ	305-420mm Adjustable Length White
ECF500ADJ	555-920mm Adjustable Length White
ECF045ELB	45° Bend White
ECF100WBK	Wall Bracket
44-58kW	
KITS & EXTENSIONS (150mm dia) (Kit contents include boiler and flex adaptor, clamp and cowl)	
ECF606KIT	6m Kit
ECF608KIT	8m Kit
ECF610KIT	10m Kit
ECF612KIT	12m Kit
ECF614KIT	14m Kit
ECF616KIT	16m Kit
ECF150EXB	1000mm Length White
ECF150EXC	500mm Length White
ECF150EXD	250mm Length White
ECF256ADJ	305-420mm Adjustable Length White
ECF506ADJ	555-920mm Adjustable Length White
ECF456ELB	45° Bend White
ECF150WBK	Wall Bracket
73-100kW	
KITS & EXTENSIONS (180mm dia) (Kit contents include boiler and flex adaptor, clamp and cowl)	
ECF706KIT	6m Kit
ECF708KIT	8m Kit
ECF710KIT	10m Kit
ECF712KIT	12m Kit
ECF714KIT	14m Kit
ECF716KIT	16m Kit
ECF180EXB	1000mm Length White
ECF180EXC	500mm Length White
ECF180EXD	250mm Length White
ECF257ADJ	305-420mm Adjustable Length White
ECF507ADJ	555-920mm Adjustable Length White
ECF457ELB	45° Bend White
ECF180WBK	Wall Bracket

Extensions

1000mm Extension



500mm Extension



250mm Extension



305-420mm & 555-920mm Telescopic Extensions



Optional Extras Offset Elbow

45° elbows can be used with the Firebird conventional flue system to offset the flue. Extensions can be used between elbows.

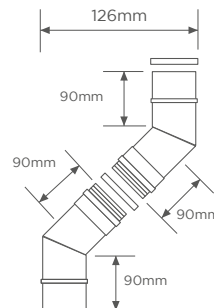

Stainless Steel Flue Kits & Accessories

High Level & Vertical Flue Kits

High level flue kits are the optimal flue system, as they provide good natural draft and ensure that the flue gases are discharged away from habitable areas.

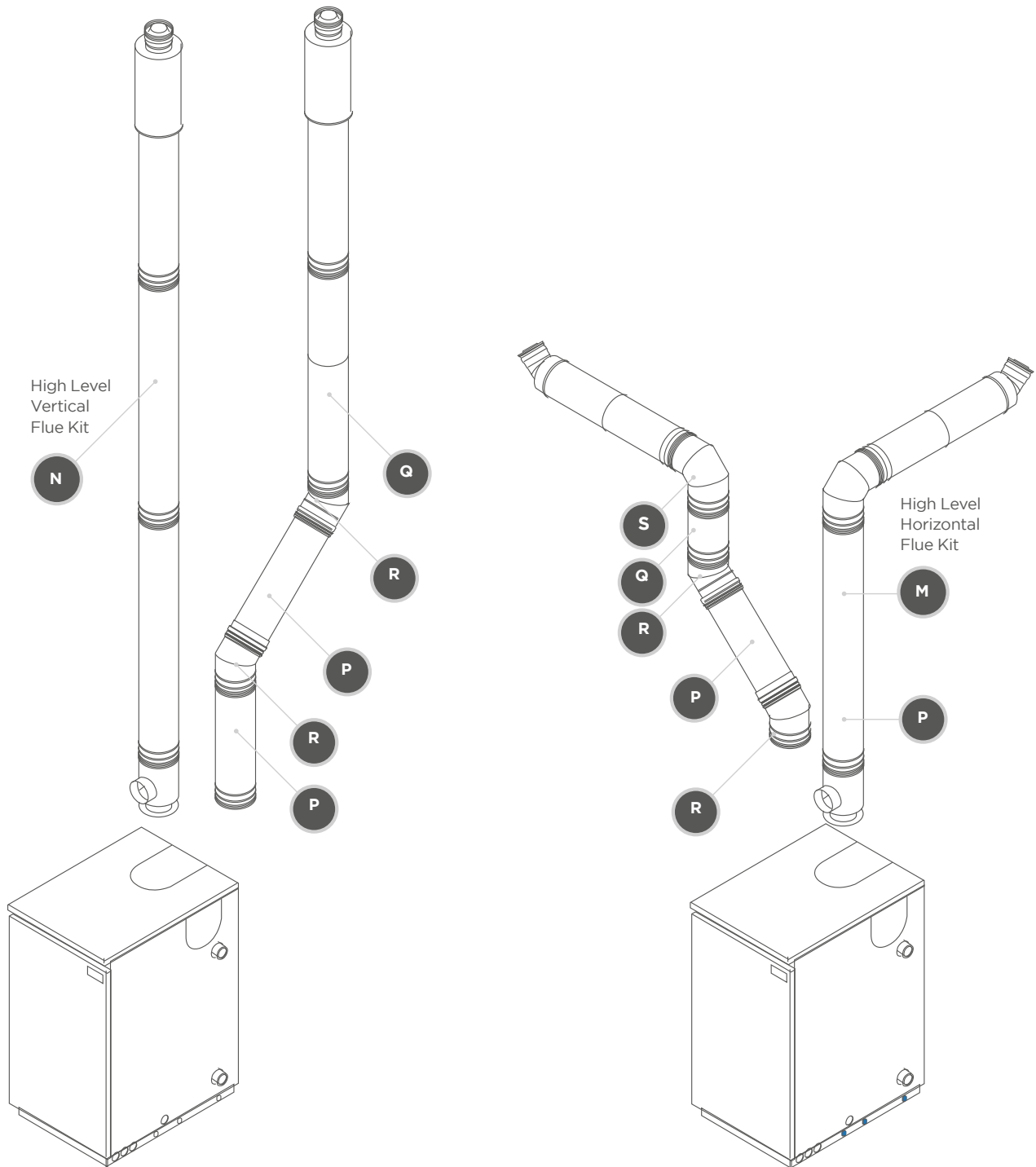

Product Code	Product Description
12-35kW KITS & EXTENSIONS (125mm dia) (White Coated)	
M HLE005HHL	1075mm High Level Horizontal Flue Kit
N HLE005VHL	3 metre Vertical Balance Flue Kit
P HLE005EXA	1000mm High Level/Vertical Extension
P HLE005EXB	500mm High Level/Vertical Extension
P HLE005EXC	250mm High Level/Vertical Extension
Q HLE005EXD	330mm Telescopic Extension
R HLE455ELB	45 degree Bend
S HLE905ELB	90 degree Bend
COF005PFL	Pitch Flashing
COF005FFL	Flat Flashing
HLF005WBK	Wall Bracket
44-58kW KITS & EXTENSIONS (150mm dia) (Stainless Steel)	
M HLF006HHL	1075mm High Level Horizontal Flue Kit
N HLF006VHL	3 metre Vertical Balance Flue Kit
P HLF006EXA	1000mm High Level/Vertical Extension
P HLF006EXB	500mm High Level/Vertical Extension
P HLF006EXC	250mm High Level/Vertical Extension
Q HLF006EXD	305mm-420mm Adjustable Length
Q HLF006EXE	555mm-920mm Adjustable Length
R HLF456ELB	45 degree Bend
S HLF906ELB	90 degree Bend
COF006PFL	Pitch Flashing
COF006FFL	Flat Flashing
HLF006WBK	Wall Bracket
73kW KITS & EXTENSIONS (180mm dia) (Stainless Steel)	
M HLF007HHL	1075mm High Level Horizontal Flue Kit
N HLF007VHL	3 metre Vertical Balance Flue Kit
P HLF007EXA	1000mm High Level/Vertical Extension
P HLF007EXB	500mm High Level/Vertical Extension
P HLF007EXC	250mm High Level/Vertical Extension
Q HLF007EXD	305mm-420mm Adjustable Length
Q HLF007EXE	555mm-920mm Adjustable Length
R HLF457ELB	45 degree Bend
S HLF907ELB	90 degree Bend
HLF007WBK	Wall Bracket
100kW KITS & EXTENSIONS (200mm dia) (Stainless Steel)	
M HLF008HHL	1075mm High Level Horizontal Flue Kit
N HLF008VHL	3 metre Vertical Balance Flue Kit
P HLF008EXA	1000mm High Level/Vertical Extension
P HLF008EXB	500mm High Level/Vertical Extension
P HLF008EXC	250mm High Level/Vertical Extension
Q HLF008EXD	305mm-420mm Adjustable Length
Q HLF008EXE	555mm-920mm Adjustable Length
R HLF458ELB	45 degree Bend
S HLF908ELB	90 degree Bend
HLF008WBK	Wall Bracket

***M - High Level Horizontal Flue Kit**

All High Level Horizontal Flue Kits contain:

- Boiler Adaptor
- 1000mm Vertical Length
- 90° Bend
- Jubilee Clip for Air Snorkel
- Wall Seal
- Silicone Lubricant
- Assembly Instruction
- Horizontal Terminal -
20-35kW = 500mm Fixed,
44-100kW = 300-500mm Adj.

***N - Vertical Flue Kit**

All Vertical Flue Kits contain:

- Boiler Adaptor
- Storm Collar
- 2 x Wall Brackets
- Silicone Lubricant
- Jubilee Clip for Air Snorkel
- Assembly Instructions
- 2 x 1000mm Lengths
- Rain Cowl
- 1000mm Length Including Terminal

Customer Service

We, the Firebird team, offer you, our customer, top quality service. We monitor the level of service provided on a regular basis to ensure our customers' requirements are always met.



Technical Support

Our Technical team will provide you with a comprehensive technical support package which is designed to make the specification and installation process as simple as possible. Please contact the Firebird Technical team on **01752 691177** or **technical@firebird.uk.com**.



Quality

At Firebird, we produce our appliances to the highest standards and put them through rigorous testing procedures by external standards agencies. We design each product to meet specific requirements and we manufacture using premium quality materials to precise standards and tolerances.



Warranty

We offer a 5 year warranty on Firebird Boilers, Heat Pumps, Solar Panels, Stoves and Range Cookers. Full warranty details can be viewed on our website at **www.firebird.uk.com**.



Environment



Innovation



Technology

United Kingdom

Firebird
Phoenix House
Eastern Wood Road
Language Industrial Estate
Plympton
Plymouth, PL7 5ET
United Kingdom

t: +44(0)1752 691177
f: +44(0)1752 691131
e: sales@firebird.uk.com

Northern Ireland

Firebird
Shean
Forkhill
Newry
BT35 9SY
Northern Ireland

t: +44 (0)28 3088 8330
f: +44(0)28 3088 9096
e: salesni@firebird.ie

Firebird Ireland

Firebird
Údáras Industrial Estate
Baile Mhic Íre
Co. Cork
P12 HK51
Ireland

t: +353(0)26 45253
f: +353(0)26 45309
e: sales@firebird.ie

This brochure was correct at the time of going to print. However, Firebird's policy is one of continuous development. The right is reserved to change specifications, colour, and prices of the models and items illustrated and described in the publication at any time. Whilst every care has been exercised in the production of this brochure, Firebird cannot accept any liability for errors or omissions. For current details always consult Firebird.

BROBEBUK000

www.firebird.uk.com | www.firebird.ie



UNITED KINGDOM



IRELAND